



UPC1678GV

2 GHz MEDIUM POWER BROADBAND SILICON MMIC AMPLIFIER

FEATURES

- **HIGH OUTPUT POWER:** +18 dBm PSAT
- **EXCELLENT FREQUENCY RESPONSE:**
2.0 GHz TYP at 3 dB Down
- **HIGH POWER GAIN:** 23 dB TYP at 500 MHz
- **SINGLE SUPPLY VOLTAGE:** 5 V
- **AVAILABLE IN TAPE AND REEL**

DESCRIPTION

NEC's UPC1678GV is a silicon monolithic integrated circuit designed as a wide-band amplifier covering the HF to UHF bands. The device features high output power, 18 dBm TYP, high gain, 23 dB TYP and operates from a single 5 volt supply.

NEC's stringent quality assurance and test procedures ensure the highest reliability and performance.

**NOISE FIGURE AND GAIN
vs. FREQUENCY AND VOLTAGE**

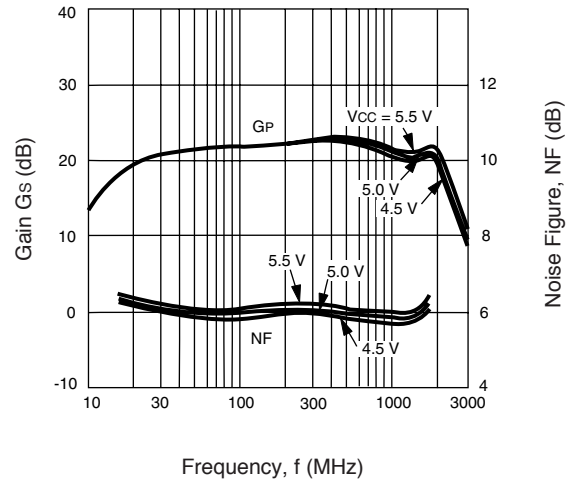

ELECTRICAL CHARACTERISTICS (TA = 25°C, VCC = +5 V, f = 500 MHz, ZL = Zs = 50 Ω)

PART NUMBER PACKAGE OUTLINE			UPC1678GV S08		
SYMBOLS	PARAMETERS AND CONDITIONS	UNITS	MIN	TYP	MAX
I _{CC}	Circuit Current at No Input Signal	mA	40	49	60
G _s	Small Signal Gain	dB	21	23	25
f _{3dB}	Upper Limit Operating Frequency at 3 dB down below the Gain at 100 MHz	MHz	1700	2000	
P _{SAT}	Saturated Output Power, P _{IN} = +3 dBm	dBm	+15.5	+17.5	
NF	Noise Figure	dB	—	6.0	8.0
RL _{IN}	Input Return Loss	dB	11	14	
RL _{OUT}	Output Return Loss	dB	1	4	
ISOL	Isolation	dB	30	35	

The information in this document is subject to change without notice. Before using this document, please confirm that this is the latest version.

ABSOLUTE MAXIMUM RATINGS¹ (T_A = 25°C)

SYMBOLS	PARAMETERS	UNITS	RATINGS
V _{CC}	Power Supply Voltage	V	-0.5 to 6.0
P _{IN}	Input Power	dBm	+10
P _T	Total Power Dissipation ²	mW	330
T _{OP}	Operating Temperature	°C	-45 to +85
T _{STG}	Storage Temperature	°C	-55 to +150

Notes:

1. Operation in excess of any one of these parameters may result in permanent damage.
2. Mounted on 50 x 50 x 1.6 mm glass epoxy PWB at T_A = +85°C.

RECOMMENDED OPERATING CONDITIONS

SYMBOLS	CHARACTERISTICS	UNITS	MIN	TYP	MAX
V _{CC}	Supply Voltage	V	4.5	5.0	5.5
T _{OP}	Operating Temperature	°C	-40	+25	+85

PIN DESCRIPTIONS

Pin No.	Pin Name	Applied Voltage (V)	Description	Internal Equivalent Circuit
1	Input	–	Signal input pin. An internal matching circuit, configured with resistors, enables a 50 Ω connection over a wide band. A multi-feedback circuit is designed to cancel the deviations of h _{FE} and resistance. This pin must be coupled to the signal source with a blocking capacitor.	
5	Output	Voltage same as V _{CC} through external inductor	Signal output pin. This output is designed as an open collector for Darlington transistors. Connect an inductor between this pin and V _{CC} pin to supply current to the internal output transistors. The inductor should be selected for high frequency use and small DC resistance.	
8	V _{CC}	4.5 to 5.5	Power supply pin. This pin should be externally equipped with a bypass capacitor to minimize ground impedance.	
6 7	GND	0	Ground pins of internal input stage. Form a ground pattern as wide as possible to minimize ground impedance.	
2 3 4	GND	0	Ground pins of internal output stage. All the ground pins including pins 6 and 7 must be connected together with a wide ground pattern to decrease impedance difference.	

Note:

Pin Voltage for Pin 1 is 1.17, measured at V_{CC} = V_{OUT} = 5.0 V.

TYPICAL PERFORMANCE CURVES (TA = 25°C)

CIRCUIT CURRENT vs. SUPPLY VOLTAGE

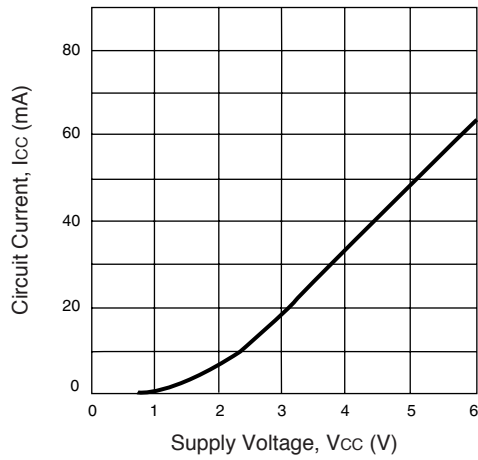

CIRCUIT CURRENT vs. OPERATING TEMPERATURE

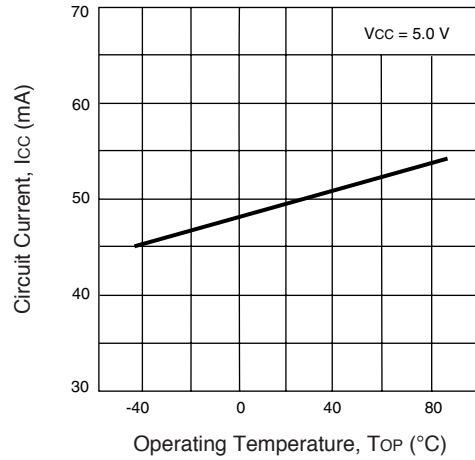

ISOLATION vs. FREQUENCY

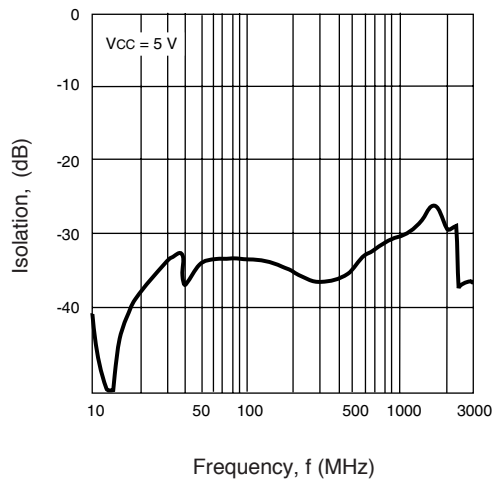

INPUT RETURN LOSS vs. FREQUENCY

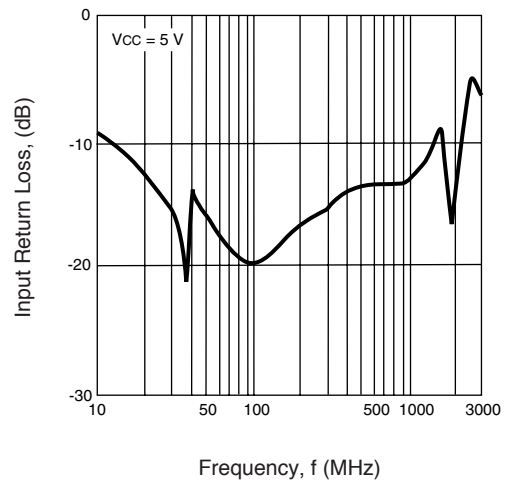

OUTPUT RETURN LOSS vs. FREQUENCY

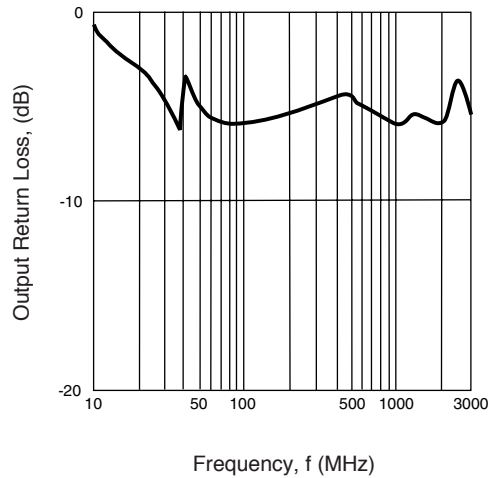

OUTPUT POWER vs. INPUT POWER

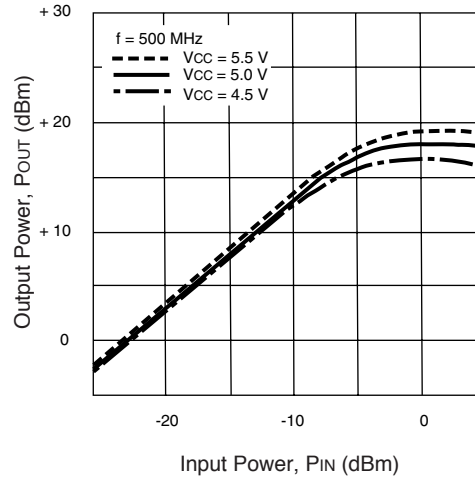

TYPICAL PERFORMANCE CURVES (TA = 25°C)

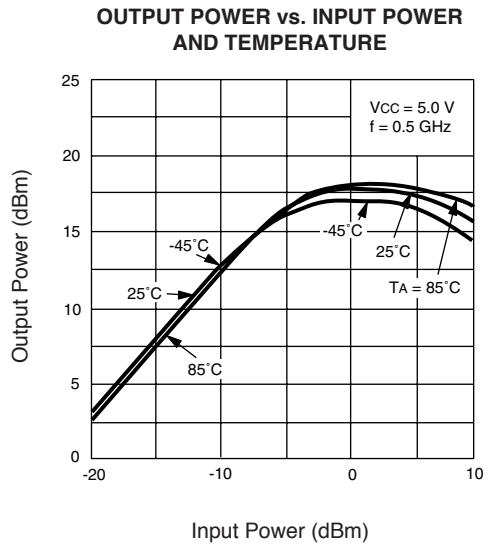
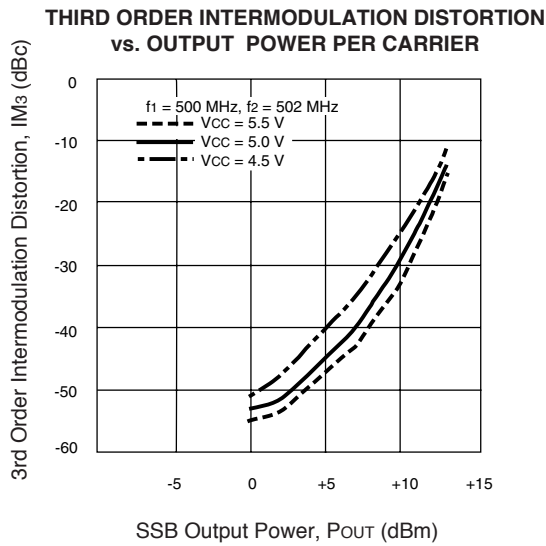
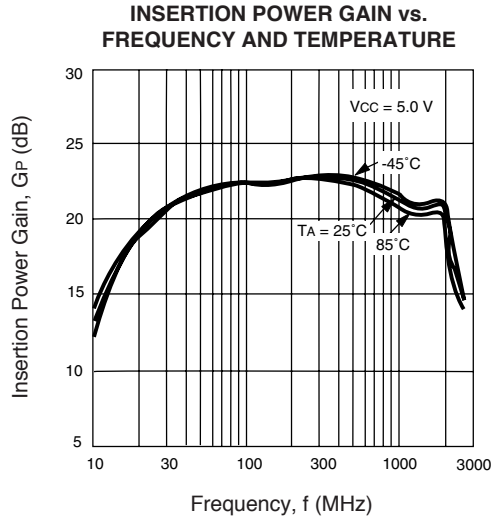
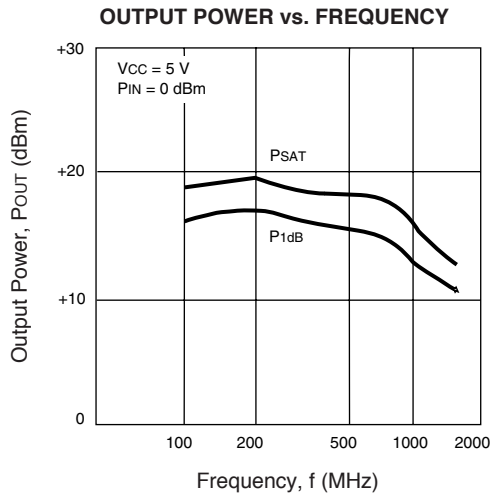

TEST CIRCUIT

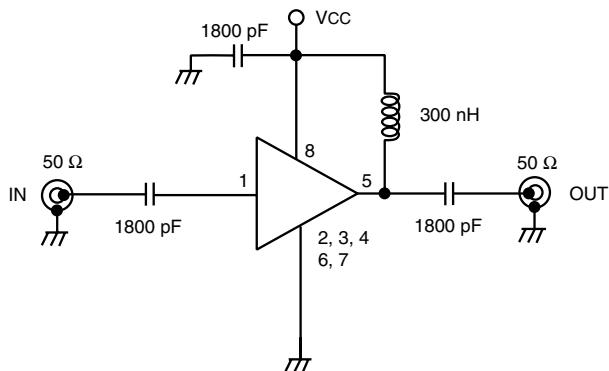

Precautions: 1) These devices are ESD sensitive. Use proper precautionary measures when handling and installing these devices.

TYPICAL SCATTERING PARAMETERS ($V_{CC} = 5.0\text{ V}$, $T_A = 25^\circ\text{C}$)

S11 Frequency

- 1: 40.846 Ω
1.9785 Ω
100 MHz
- 2: 43.174 Ω
12.344 Ω
500 MHz
- 3: 66.441 Ω
-14.414 Ω
1.7 GHz

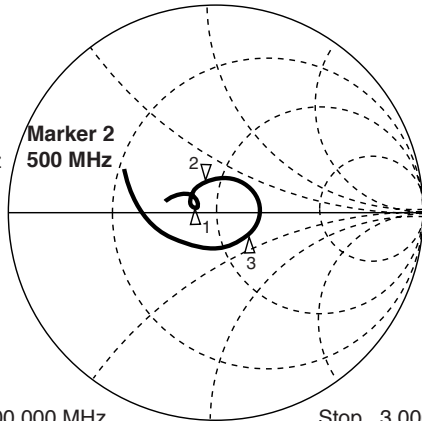

Start 10.000 000 MHz Stop 3.000 000 MHz

S22 Frequency

- 1: 121.86 Ω
71.563 Ω
100 MHz
- 2: 77.645 Ω
-111.17 Ω
500 MHz
- 3: 26.904 Ω
-34.393 Ω
1.7 GHz

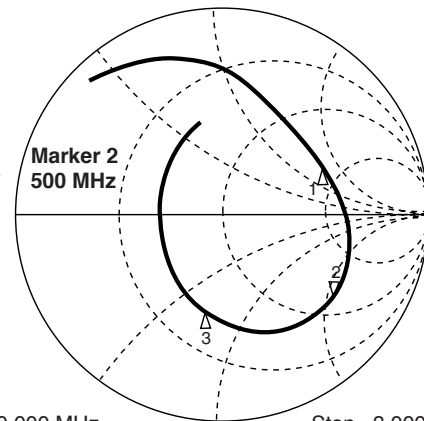

Start 10.000 000 MHz Stop 3.000 000 MHz

UPC1678GV

$V_{CC} = 5\text{ V}$, $I_{CC} = 50\text{ mA}$

FREQUENCY (GHz)	S11		S21		S12		S22		K	S21 (dB)
	MAG	ANG	MAG	ANG	MAG	ANG	MAG	ANG		
0.05	0.136	157	10.2	36	0.018	3	0.683	89	1.59	23.0
0.10	0.106	164	12.1	18	0.025	26	0.609	53	1.25	23.8
0.20	0.126	165	13.2	3	0.020	15	0.621	22	1.34	24.6
0.40	0.174	144	14.4	-17	0.017	50	0.673	-10	1.24	26.4
0.60	0.184	119	15.0	-35	0.024	71	0.657	-37	0.85	27.9
0.80	0.150	107	14.6	-52	0.033	75	0.619	-64	0.78	26.5
1.00	0.102	115	15.1	-70	0.038	77	0.599	-89	0.78	26.0
1.20	0.112	148	14.0	-88	0.040	83	0.585	-116	0.81	25.4
1.40	0.169	151	12.4	-114	0.046	92	0.542	-142	0.81	24.4
1.60	0.180	137	11.3	-131	0.054	99	0.449	-163	0.86	23.2
1.80	0.146	121	7.6	-144	0.063	101	0.335	-177	1.10	18.8
2.00	0.072	89	6.2	-159	0.073	102	0.224	-177	1.25	16.2
2.20	0.045	-37	4.6	-157	0.081	100	0.192	-163	1.49	13.4
2.40	0.137	-84	3.9	-164	0.085	97	0.206	-157	1.60	12.1
2.50	0.180	-95	3.9	-161	0.088	95	0.219	-158	1.54	12.2

OUTLINE DIMENSIONS (Units in mm)

**UPC1678GV
PACKAGE OUTLINE S08**

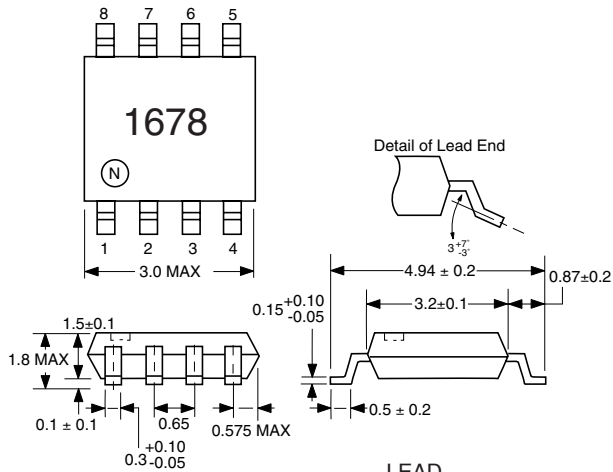

- LEAD CONNECTIONS**
- 1. Input 5. Output
 - 2. GND 6. GND
 - 3. GND 7. GND
 - 4. GND 8. Vcc

ORDERING INFORMATION (Solder Contains Lead)

PART NUMBER	QTY
UPC1678GV-E1	1000/REEL

Note: Embossed tape, 8 mm wide. Pin 1 is in tape pull-out direction.

ORDERING INFORMATION (Pb-Free)

PART NUMBER	QTY
UPC1678GV-E1-A	1000/REEL

Note: Embossed tape, 8 mm wide. Pin 1 is in tape pull-out direction.

Life Support Applications

These NEC products are not intended for use in life support devices, appliances, or systems where the malfunction of these products can reasonably be expected to result in personal injury. The customers of CEL using or selling these products for use in such applications do so at their own risk and agree to fully indemnify CEL for all damages resulting from such improper use or sale.

Subject: Compliance with EU Directives

CEL certifies, to its knowledge, that semiconductor and laser products detailed below are compliant with the requirements of European Union (EU) Directive 2002/95/EC Restriction on Use of Hazardous Substances in electrical and electronic equipment (RoHS) and the requirements of EU Directive 2003/11/EC Restriction on Penta and Octa BDE.

CEL Pb-free products have the same base part number with a suffix added. The suffix –A indicates that the device is Pb-free. The –AZ suffix is used to designate devices containing Pb which are exempted from the requirement of RoHS directive (*). In all cases the devices have Pb-free terminals. All devices with these suffixes meet the requirements of the RoHS directive.

This status is based on CEL’s understanding of the EU Directives and knowledge of the materials that go into its products as of the date of disclosure of this information.

Restricted Substance per RoHS	Concentration Limit per RoHS (values are not yet fixed)	Concentration contained in CEL devices	
		-A	-AZ
Lead (Pb)	< 1000 PPM	Not Detected	(*)
Mercury	< 1000 PPM	Not Detected	
Cadmium	< 100 PPM	Not Detected	
Hexavalent Chromium	< 1000 PPM	Not Detected	
PBB	< 1000 PPM	Not Detected	
PBDE	< 1000 PPM	Not Detected	

If you should have any additional questions regarding our devices and compliance to environmental standards, please do not hesitate to contact your local representative.

Important Information and Disclaimer: Information provided by CEL on its website or in other communications concerning the substance content of its products represents knowledge and belief as of the date that it is provided. CEL bases its knowledge and belief on information provided by third parties and makes no representation or warranty as to the accuracy of such information. Efforts are underway to better integrate information from third parties. CEL has taken and continues to take reasonable steps to provide representative and accurate information but may not have conducted destructive testing or chemical analysis on incoming materials and chemicals. CEL and CEL suppliers consider certain information to be proprietary, and thus CAS numbers and other limited information may not be available for release.

In no event shall CEL’s liability arising out of such information exceed the total purchase price of the CEL part(s) at issue sold by CEL to customer on an annual basis.

See CEL Terms and Conditions for additional clarification of warranties and liability.