

# HiPerFAST™ IGBT

# IXGH 24N60B

$V_{CES} = 600 \text{ V}$   
 $I_{C25} = 48 \text{ A}$   
 $V_{CE(sat)} = 2.3 \text{ V}$   
 $t_{fi} = 80 \text{ ns}$

Preliminary Data

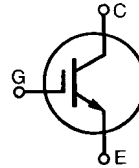

Symbol	Test Conditions	Maximum Ratings	
$V_{CES}$	$T_J = 25^\circ\text{C to } 150^\circ\text{C}$	600	V
$V_{CGR}$	$T_J = 25^\circ\text{C to } 150^\circ\text{C}; R_{GE} = 1 \text{ M}\Omega$	600	V
$V_{GES}$	Continuous	$\pm 20$	V
$V_{GEM}$	Transient	$\pm 30$	V
$I_{C25}$	$T_C = 25^\circ\text{C}$	48	A
$I_{C90}$	$T_C = 90^\circ\text{C}$	24	A
$I_{CM}$	$T_C = 25^\circ\text{C}, 1 \text{ ms}$	96	A
<b>SSOA (RBSOA)</b>	$V_{GE} = 15 \text{ V}, T_{VJ} = 125^\circ\text{C}, R_G = 22 \Omega$ Clamped inductive load	$I_{CM} = 48$ @ $0.8 V_{CES}$	A
$P_C$	$T_C = 25^\circ\text{C}$	150	W
$T_J$		-55 ... +150	$^\circ\text{C}$
$T_{JM}$		150	$^\circ\text{C}$
$T_{stg}$		-55 ... +150	$^\circ\text{C}$
Maximum lead temperature for soldering 1.6 mm (0.062 in.) from case for 10 s		300	$^\circ\text{C}$
$M_d$	Mounting torque (M3)	1.13/10	Nm/lb.in.
<b>Weight</b>		6	g

TO-247 AD

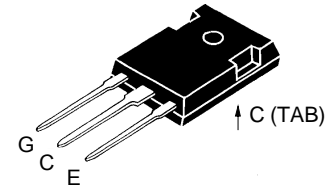

G = Gate, C = Collector,  
E = Emitter, TAB = Collector

### Features

- International standard packages  
JEDEC TO-247 SMD surface mountable and JEDEC TO-247 AD
- High frequency IGBT
- High current handling capability
- 3rd generation HDMOS™ process
- MOS Gate turn-on  
- drive simplicity

### Applications

- AC motor speed control
- DC servo and robot drives
- DC choppers
- Uninterruptible power supplies (UPS)
- Switched-mode and resonant-mode power supplies

### Advantages

- High power density
- Switching speed for high frequency applications
- Easy to mount with 1 screw  
(insulated mounting screw hole)

Symbol	Test Conditions	Characteristic Values ( $T_J = 25^\circ\text{C}$ , unless otherwise specified)		
		min.	typ.	max.
$BV_{CES}$	$I_C = 250 \mu\text{A}, V_{GE} = 0 \text{ V}$	600		V
$V_{GE(th)}$	$I_C = 250 \mu\text{A}, V_{CE} = V_{GE}$	2.5		V
$I_{CES}$	$V_{CE} = 0.8 \cdot V_{CES}$ $V_{GE} = 0 \text{ V}$			200 $\mu\text{A}$ 1 mA
$I_{GES}$	$V_{CE} = 0 \text{ V}, V_{GE} = \pm 20 \text{ V}$			$\pm 100 \text{ nA}$
$V_{CE(sat)}$	$I_C = I_{C90}, V_{GE} = 15 \text{ V}$			2.3 V

Symbol	Test Conditions	Characteristic Values		
		$(T_J = 25^\circ\text{C}, \text{ unless otherwise specified})$		
		min.	typ.	max.
$g_{fs}$	$I_C = I_{C90}, V_{CE} = 10\text{ V}$ Pulse test, $t \leq 300\ \mu\text{s}$ , duty cycle $\leq 2\%$	9	13	S
$C_{ies}$	$V_{CE} = 25\text{ V}, V_{GE} = 0\text{ V}, f = 1\text{ MHz}$		1500	pF
$C_{oes}$			175	pF
$C_{res}$			40	pF
$Q_g$	$I_C = I_{C90}, V_{GE} = 15\text{ V}, V_{CE} = 0.5 V_{CES}$		90	120 nC
$Q_{ge}$			11	15 nC
$Q_{gc}$			30	40 nC
$t_{d(on)}$	<b>Inductive load, <math>T_J = 25^\circ\text{C}</math></b> $I_C = I_{C90}, V_{GE} = 15\text{ V}$ $V_{CE} = 0.8 V_{CES}, R_G = R_{off} = 10\ \Omega$ Remarks: Switching times may increase for $V_{CE}(\text{Clamp}) > 0.8 \cdot V_{CES}$ , higher $T_J$ or increased $R_G$		25	ns
$t_{ri}$			15	ns
$E_{on}$			0.6	mJ
$t_{d(off)}$			150	200 ns
$t_{fi}$			80	150 ns
$E_{off}$		24N60B	0.80	mJ
$t_{d(on)}$	<b>Inductive load, <math>T_J = 125^\circ\text{C}</math></b> $I_C = I_{C90}, V_{GE} = 15\text{ V}$ $V_{CE} = 0.8 V_{CES}, R_G = R_{off} = 10\ \Omega$ Remarks: Switching times may increase for $V_{CE}(\text{Clamp}) > 0.8 \cdot V_{CES}$ , higher $T_J$ or increased $R_G$		25	ns
$t_{ri}$			15	ns
$E_{on}$			0.8	mJ
$t_{d(off)}$			250	ns
$t_{fi}$			100	ns
$E_{off}$		24N60B	1.4	mJ
$R_{thJC}$				0.83 K/W
$R_{thCK}$		0.25		K/W

### TO-247 AD Outline

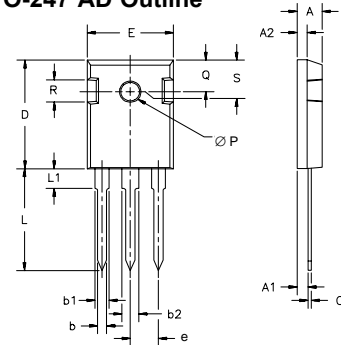

Dim.	Millimeter		Inches	
	Min.	Max.	Min.	Max.
A	4.7	5.3	.185	.209
A <sub>1</sub>	2.2	2.54	.087	.102
A <sub>2</sub>	2.2	2.6	.059	.098
b	1.0	1.4	.040	.055
b <sub>1</sub>	1.65	2.13	.065	.084
b <sub>2</sub>	2.87	3.12	.113	.123
C	.4	.8	.016	.031
D	20.80	21.46	.819	.845
E	15.75	16.26	.610	.640
e	5.20	5.72	0.205	0.225
L	19.81	20.32	.780	.800
L <sub>1</sub>		4.50		.177
ØP	3.55	3.65	.140	.144
Q	5.89	6.40	0.232	0.252
R	4.32	5.49	.170	.216
S	6.15	BSC	242	BSC

### TO-247 SMD Outline

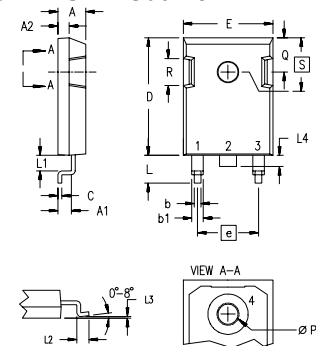

- Gate
- Collector
- Emitter
- Collector

Dim.	Millimeter		Inches	
	Min.	Max.	Min.	Max.
A	4.83	5.21	.190	.205
A <sub>1</sub>	2.29	2.54	.090	.100
A <sub>2</sub>	1.91	2.16	.075	.085
b	1.14	1.40	.045	.055
b <sub>1</sub>	1.91	2.13	.075	.084
C	0.61	0.80	.024	.031
D	20.80	21.34	.819	.840
E	15.75	16.13	.620	.635
e	5.45	BSC	.215	BSC
L	4.90	5.10	.193	.201
L <sub>1</sub>	2.70	2.90	.106	.114
L <sub>2</sub>	2.10	2.30	.083	.091
L <sub>3</sub>	0.00	0.10	.00	.004
L <sub>4</sub>	1.90	2.10	.075	.083
ØP	3.55	3.65	.140	.144
Q	5.59	6.20	.220	.244
R	4.32	4.83	.170	.190
S	6.15	BSC	.242	BSC

### Min. Recommended Footprint (Dimensions in inches and (mm))

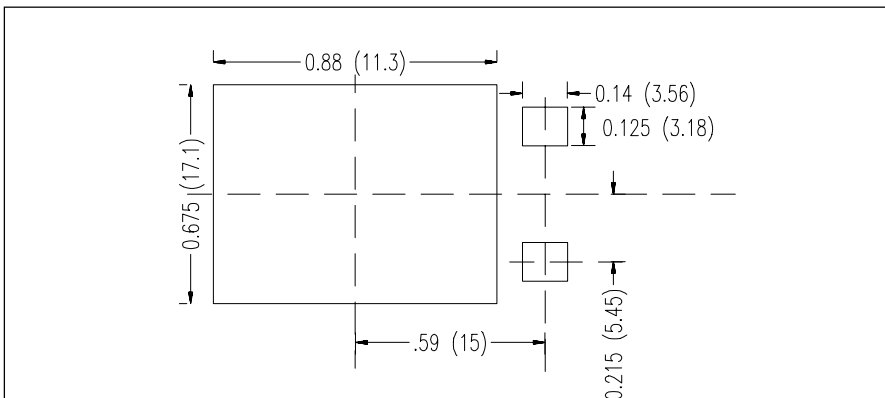

IXYS reserves the right to change limits, test conditions, and dimensions.

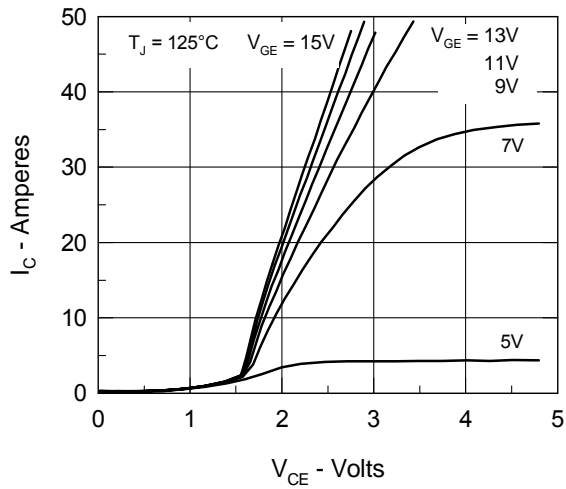

Fig. 1. Saturation Voltage Characteristics

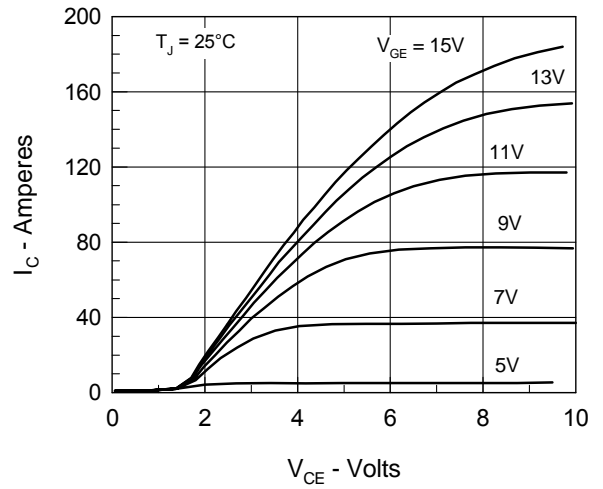

Fig. 2. Extended Output Characteristics

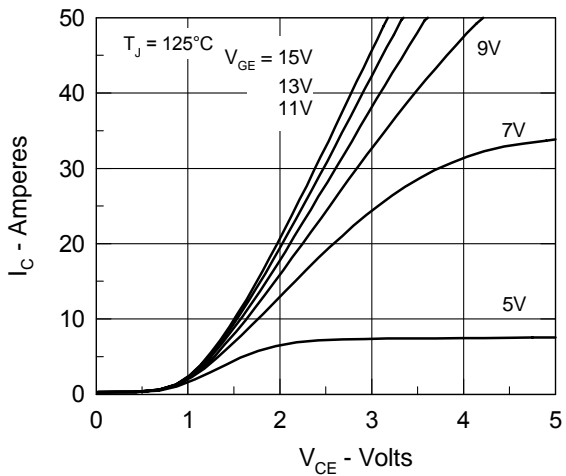

Fig. 3. Saturation Voltage Characteristics

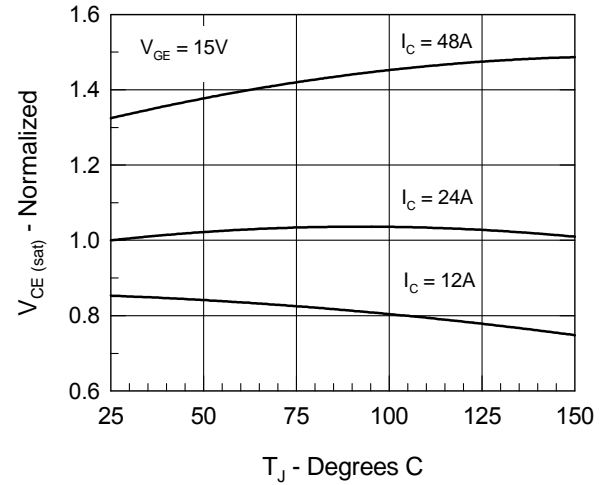
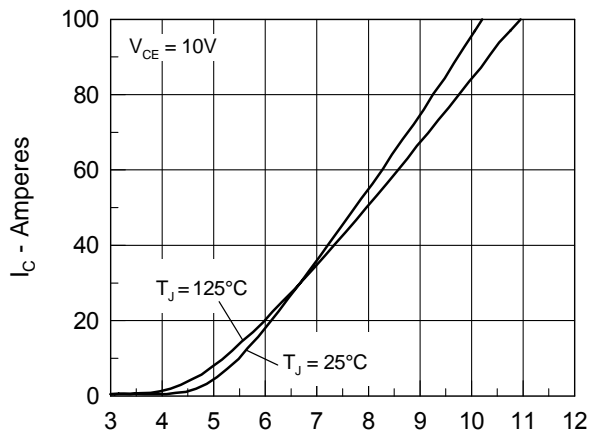
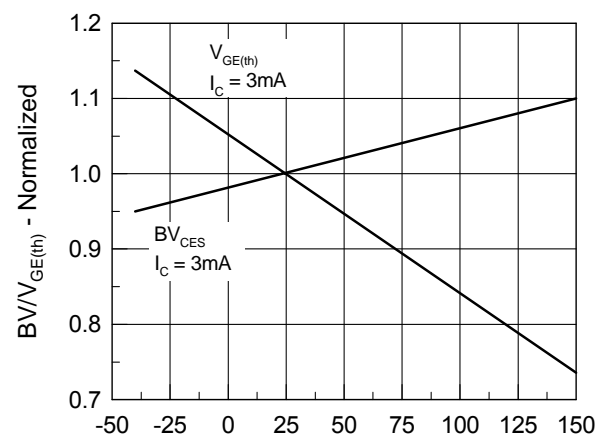

 Fig. 4. Temperature Dependence of  $V_{CE(sat)}$ 

Fig. 5. Admittance Curves

 Fig. 6. Temperature Dependence of  $BV_{DSS}$  &  $V_{GE(th)}$

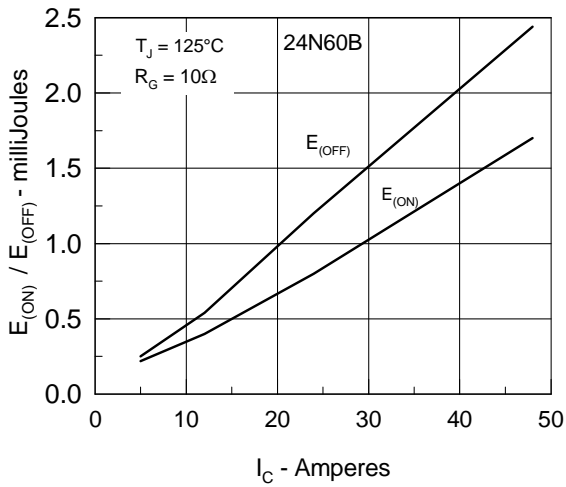

Fig. 7. Dependence of  $t_{fi}$  and  $E_{OFF}$  on  $I_C$ .

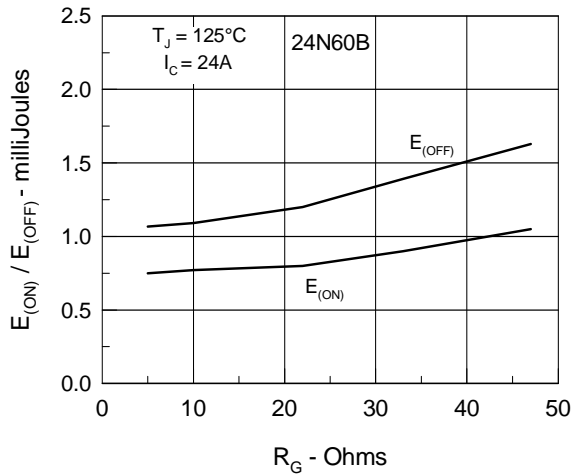

Fig. 8. Dependence of  $t_{fi}$  and  $E_{OFF}$  on  $R_G$ .

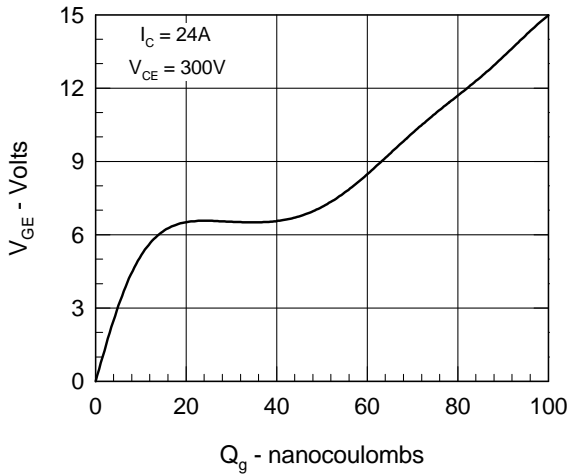

Fig. 9. Gate Charge

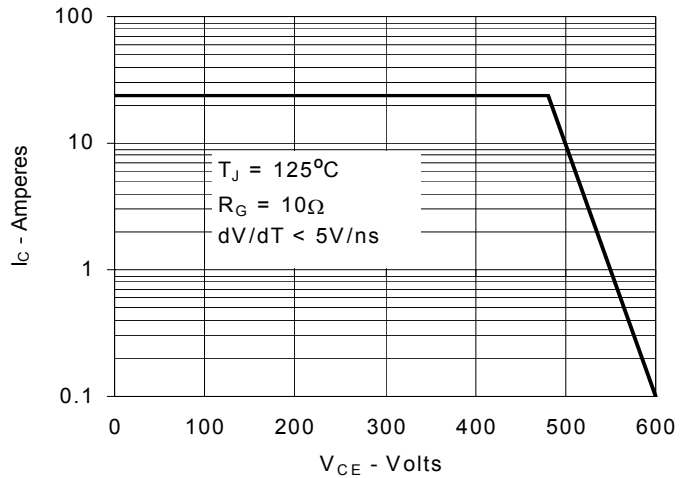

Fig. 10. Turn-off Safe Operating Area

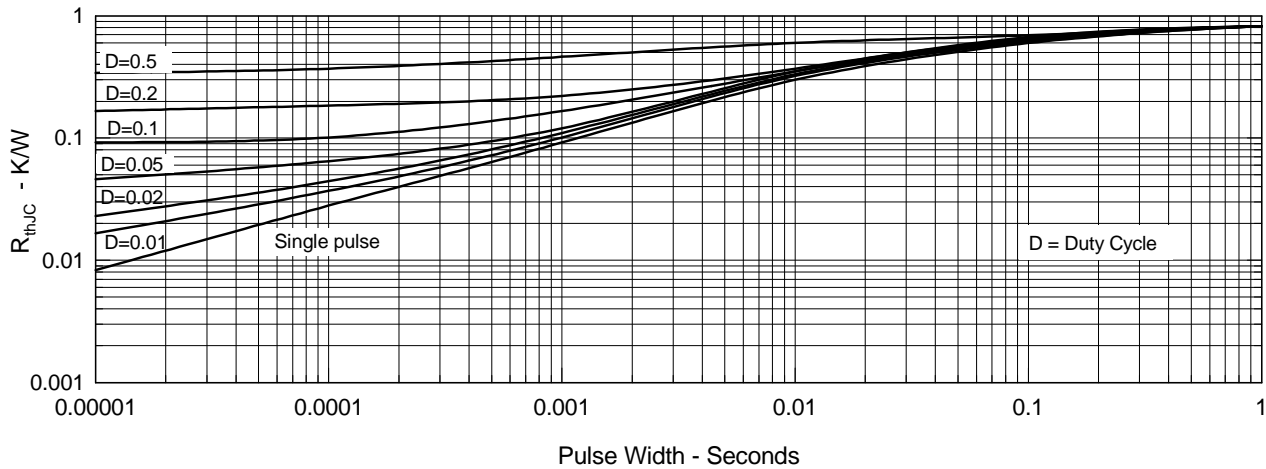

Fig. 11. Transient Thermal Resistance

IXYS reserves the right to change limits, test conditions, and dimensions.

IXYS MOSFETs and IGBTs are covered by one or more of the following U.S. patents:

4,835,592	4,881,106	5,017,508	5,049,961	5,187,117	5,486,715	6,306,728B1
4,850,072	4,931,844	5,034,796	5,063,307	5,237,481	5,381,025	